

# OPERATORS FOR SWING GATES QK-E400FCA

## INSTALLATION MANUAL V02

Our compliments for your excellent choice. The QK-E400FCA electro-mechanical gear motor has been produced for reliability and high quality.

This Manual will offer information you may need to install your gear motor assuring long-lasting performance and to safeguard your safety.

**HOWEVER CAUTION IS UNQUESTIONABLY INDISPENSABLE AND NOTHING IS BETTER THAN PREVENTING ACCIDENTS.**

QUIKO ITALY products have been made to conform with rules and laws in force at time of manufacture.

 This manual is designed exclusively for the specialized installation expert in the criteria of construction and equipment to assist in the protection against accidents in the installation and use of the gate; door and automation of such gates (adhere to the rules and laws in force).

 On completion the installer should issue to the end consumer an instruction manual according to EN 12635.

 Before proceeding with the installation the installer must provide an analysis of the identification and management of risks as per the standards EN 12453 and EN 12445.

 All wiring of the various external electrical components connected to the automation (e.g. Photocells, flashing lights, keypads etc) must be carried out according to EN 60204-1 and the amendments made of the point 5.2.2 of EN 12453.

 It is prohibited to do any repair or adjustment of the equipment if you have not taken all necessary precautions to avoid possible accidents (example: power supply disconnected, engine block). All mechanisms in motion must be equipped with appropriate protections.

 The mains power line must be protected for maximum current in locked rotor condition as per government electrical laws.

 Install the gear motor on gates that conform to EN 12604.

 Perform the measure of strength developed by the gear motor and take the appropriate steps as per EN 12445.

 Positioning photocells: These safety devices must be installed at a height not exceeding 70cm from the ground and at a distance from the floor movement of the door of no more than 20cm. Their proper functioning of the photocells must be verified at the end of installation according to Section 7.2.1 of EN12445.

 Keep the activation controls of automation out of reach of children. The controls should be installed at a minimum 1.5m height above the ground and outside the range of actions of moving parts such as the gate.

 All activation actions must be executed only at points from where the automation is fully visible.

 Operate the remote only in view of automation.

 Store carefully this manual in a suitable place known to all interested people.

 Any unauthorized and arbitrary modification made to this product, releases the company MANUFACTURER and from any liability resulting from damage or injury to things, people or animals.

 The non-observance of regulations and of safety standards here listed releases the company MANUFACTURER from any liability resulting from damage or injury to things, people or animals.

 The automation must be coupled to a control board equipped with torque regulation that provides an anti crushing safety as described in EN 12453 - EN 12445

## SAFETY RULES

During the installation and the use of the automation, pay attention to the following safety rules:

 Distance security!

 Mechanisms moving!

 Do not install automation in an environment saturated with explosive mixtures!

 Electric Shock!

 Use gloves!

 Use welding glasses!

 Maintain ear protection!

## MAINTENANCE

 All repairs must be carried out by qualified people.

 Before each intervention remove power through the switch and lock in that position

 The equipment must be maintained so as to preserve the conditions that ensure safe and efficient operation

 Always use original spare parts

 Do not make interventions that modify the machine.

 The modified equipment requires new CE mark

 The settings of the operator must be performed by qualified personnel, in accordance with the rules of reference. During these operations provide the presence of two operators for safety.

**DEMOLITION**

You have to operate the elimination of the materials in conformity with the regulations in force. All materials must be divided by type (copper, aluminium, plastic, electrical parts, etc)

**DISMANTLING**

In order to move away the automation, follow these instructions:

1 - cut off the power supply and disconnect the electrical installation;  
2 - dismantle the control console and all the other components of the installation.

If you have noticed that some components have been damaged, you have to replace them.

**CONFORMITY DECLARATION:**

It's in accordance with Machine Directive 39/89/CE and following modify.

It's in accordance with the following directive CE:

Electromagnetic compatibility Directive 89/336/CEE and following modify.

Low tension Directive 73/23/CEE and following modify.

Have been applied the following harmonized norms:

EN292/1/2, EN 294, EN60335-1, UNI EN 12453, and what applicable of the EN12445-2000.

**USE OF THE AUTOMATION**

The gearmotor QK-E400FCA was designed and built for the opening of gates with max of 4 m leaf or weight max. 300kg. QUIKO ITALY SRL assumes no responsibility for a purpose other than that provided by gearmotor QK-E400FCA. Since automation can be put into motion in view by button or remotely by remote control, it is essential to check frequently the perfect efficiency of all safety devices. It is advisable to check periodically (every six months) the regulation of electronic friction of which must be equipped the electronic control board.

**PRELIMINARY CHECKS**

1 - Read carefully the instructions enclosed in this manual.

2 - Make sure that the gate has a rather solid structure and that there is no friction points in its movement.

3 - Make sure that the leaf is suitably balanced, even after the installation of the gear motor.

4 - Check that the electrical installation is in accordance with the characteristic required by the gear motor.

**TECHINICAL DATA**

	<b>QK-E400FCA</b>	<b>QK-E400BFCA</b>
Maximum length of the gate	4m	4m
Maximum weight of the gate	300Kg	300Kg
Stroke	40cm	40cm
Power	350 W	70 W
Power supply	220 V	24 V
Absorption	1,5 A	0,5 – 5,5 A
Operating temperature	-30°C +70°C	-30°C +70°C
Opening time	20sec.	17sec.
Thermal protection	150°C	-
Use frequency	50%	100%
Lubrication	GREASE	

**SCHEDULED MAINTENANCE**

DESCRIPTION	FREQUENCY	ENTRUSTED	OPERATION
Photocells cleaning	Monthly	Operator	Clean with damp cloth
Control of gate hinges and supports, balancing of the gate	Annual	Operator	Check the status of welds and corrosion. Unhook the engine and check the balancing and the eventual points of friction.
Controlling the sensitivity of electronic friction (torque adjustment) of the control board.	Semiannual	Technician	Check the adjustment of the couple as described in EN 12453 - EN 12445
Monitoring current dispersion	Annual	Technician	Verify that the dispersion of current is less than 7.5 A
Control of signals	Semiannual	Operator	Verify that the safety warning signage is complete and intact

**EMERGENCY MANOEUVRE**

For the manual door locking and unlocking act with the supplied key on the screw H (See FIG 1-2).

1 - Remove the protection cap C

2 - insert the key into the seat allocation as in Figure 1

3 - Turn the key in the sense of the arrow to the top of the gearmotor to unlock and in the opposite block.

FIG1



**INSTALLATION**

- A** – Pillar bracket
- B** – Gate bracket
- C** – Release cap
- D** – Mechanical stop for closing
- E** – Mechanical stop for opening
- F** – Mounting pin

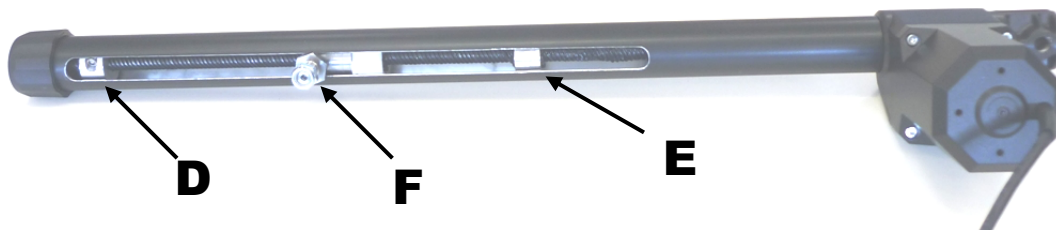
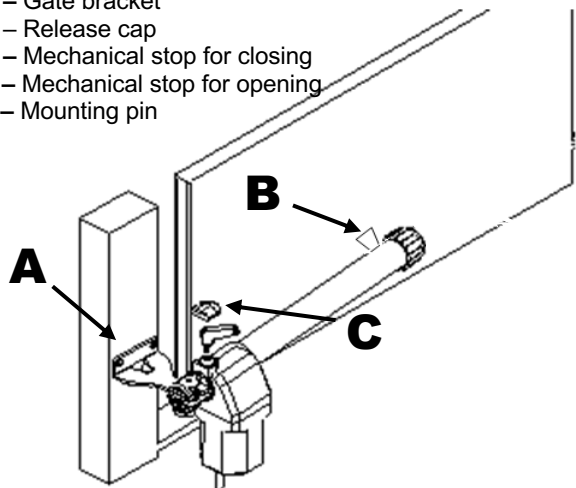
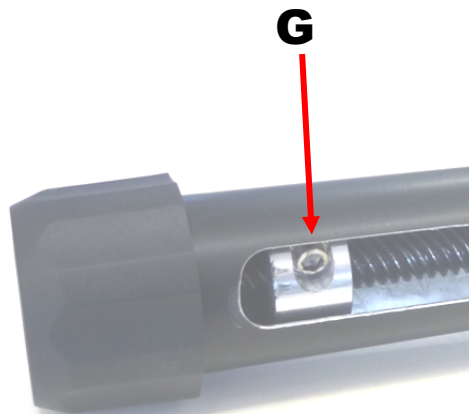

FIG 2



For proper installation of the motor follow the steps as follows.

- 1 - Open the packaging and check that the drive has not been damaged due to the transportation, etc..
- 2 - Make sure the gate is perfectly horizontal and moves freely.
- 3 - Release the motor as shown in the procedure for emergency release.
- 4 - Fix the pillar on the side of the door, the plate A, the following allowances to be respected as in FIG 1 and Table 1.

FIG 1

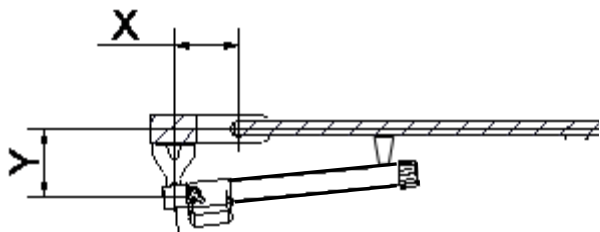

TAB 1

MOTOR	ROTATION 95 °		ROTATION 120 °	
	X	Y	X	Y
QK-E400FCA	145	145	170	110

- 5 - Install the motor on the plate A and secure it with the pin and the grub screw provided.

- 6 - With the door closed, slide the mounting pin F and the mechanical stopper D to the end of run. Fix the mounting pin F to the plate B to determine the fixing position of the plate on the leaf.

- 7 - Use the references taken to secure the support plate B to the leaf. Fasten the motor with the pin F to the plate. Check the position and fix the stopper D by tightening the screw G.

- 8 - Open the door in the desired open position and fix the limit switch E in place by tightening the screw G.



**G SCREWS: USE A MAXIMUM TIGHTENING TORQUE OF 7N**

- 9 - Repeat the steps with the other gate leaf.
- 10 - Carry out the wiring and fitting of safety devices.

- 11 - Position the cover cap C on the release pin. FIG 2

FIG 6

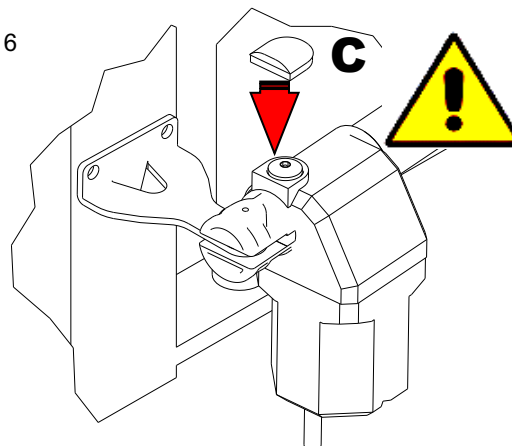

## PUSH TO OPEN SOLUTION

If necessary, when PUSH TO OPEN installation is required, extending the bracket on the pillar, it is possible to install the motor internally and let the gate open externally as per the image below:

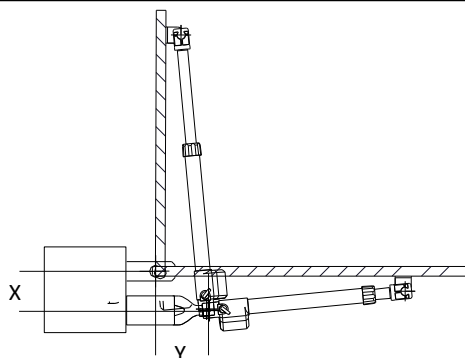

## EU Declaration of Conformity

and Declaration of Incorporation of "quasi-machines" (pursuant to the Machinery Directive 2006/42/CE, Att.II, B)



<b>Company name:</b>	<b>QUIKO ITALY SRL</b>
<b>Postal address:</b>	Via Seccalegno, 19
<b>Postcode and City:</b>	36040, Sossano (VI) - Italy
<b>Telephone number:</b>	+39 0444 785513
<b>E-Mail address:</b>	info@quikoitaly.com

declare that the DoC is issued under our sole responsibility and belongs to the following product:

<b>Apparatus model/Product:</b>	<b>Eon: QK-E400 ; QK-E400FX ; QK-E400B ; QK-E400BFX ; QK-E600 ; QK-E600FX</b>
<b>Type:</b>	AUTOMATIONS FOR SWING GATES (230/110/24V)
<b>Batch:</b>	See the label on the motor

The object of the declaration described above is in conformity with the relevant Union harmonisation legislation:

- **Directive 2006/42/CE (MD Directive)**

- It is declared that the relevant technical documentation has been drawn-up in compliance with attachment VII B.
- It is also declared that the following essential health and safety requirements have been respected: 1.1.1 - 1.1.2 - 1.1.3 - 1.1.5 - 1.2.1 - 1.2.6 - 1.3.1 - 1.3.2 - 1.3.3 - 1.3.4 - 1.3.7 - 1.3.9 - 1.5.1 - 1.5.2 - 1.5.4 - 1.5.5 - 1.5.6 - 1.5.7 - 1.5.8 - 1.5.10 - 1.5.11 - 1.5.13 - 1.6.1 - 1.6.2 - 1.6.4 - 1.7.2 - 1.7.3 - 1.7.4 - 1.7.4.1 - 1.7.4.2 - 1.7.4.3.
- The undersigned declares that the afore-mentioned "partly-completed machinery" cannot be commissioned until the final machine, into which it has been incorporated, has been declared compliant with the Machinery Directive 2006/42/CE.
- On duly justified request, the manufacturer commits to transmitting the information regarding the "partly-completed machinery" to the national authorities without prejudice to their intellectual property rights.

- **Directive 2014/53/EU (RED Directive)**

- **Directive 2011/65/EU (RoHS)**

The following harmonised standards and technical specifications have been applied:

Title:	Date of standard/specification
EN 61000-6-2	2005 + AC:2005
EN 61000-6-3	2007 + A1:2011+AC:2012,
EN 301 489-1 V2.2.3	2019
EN 301 489-3 V2.1.1	2017
EN 60335-2-103	2015
EN 12453	2017
EN 62479	2010
EN 300 220-2 V3.1.1	2017
EN IEC 63000	2018

### Additional information

Signed for and on behalf of:

<b>Revision:</b>	<b>Place and date of issue:</b>	<b>Name, function, signature</b>
01.00	Sossano, 28/09/2021	(Borinato Luca, Legal Officer)