

CHECKING IF THE MOTOR TURNS IN THE RIGHT DIRECTION

Once all the connections have been done and the system is ready to start, before setting the system it is important to check that the motors turn in the right direction. **To do that:**

1. Remove electricity.
2. Unlock the motor and manually put the leaf in the middle.
3. Give electricity.
4. Give a first start impulse with remote control or push - button.
5. Make sure that the motor opens.
6. If the motor closes, swap the phases cables of the motor (13-15) as well as limit switch cables (5-6)



MOTOR

LIMIT SWITCHES

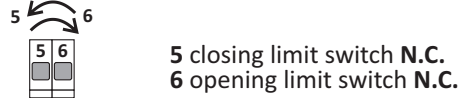
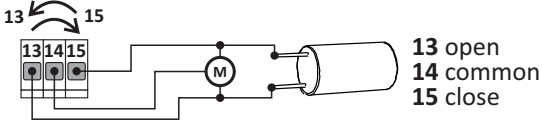

7. Once you have swapped motor phases cables as well as limit switch cables, repeat the procedure above and make sure that now the motor opens at first start signal after giving electricity.
8. The system is now ready for setup.

INSTALLING RADIO MODULE

Important notice: radio module is by factory installed on the control board plastic box. The radio signal range is good enough in most cases. Shall you wish to increase the radio range even more, install the radio module as one the following examples.

INSIDE THE ANTENNA HOUSING

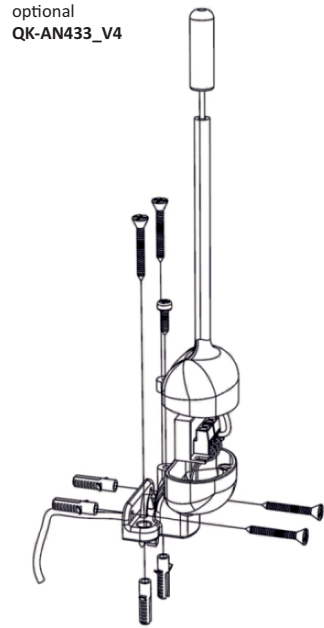

ANTENNA HOUSING WITH FLASHING LAMP

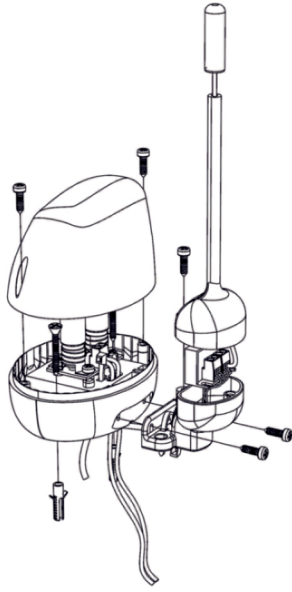

INSIDE THE FLASHING LAMP

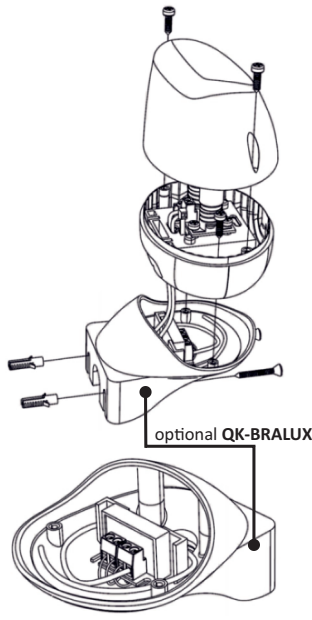

Quiko Italy declares under their own responsibility that the product complies with the main safety requirements issued by the following directives: 1) Radio Sets 1999/05/EC – 2) Low voltage 2006/95/EC – 3) Electromagnetic compatibility 2004/108/EC and any revisions thereof, and complies with the provisions that implement said directives in the national legislation of the Country where the products are to be used.



RX MODULE



RX MODULE: put inside flashing lamp or antenna housing to increase range of radio signal.

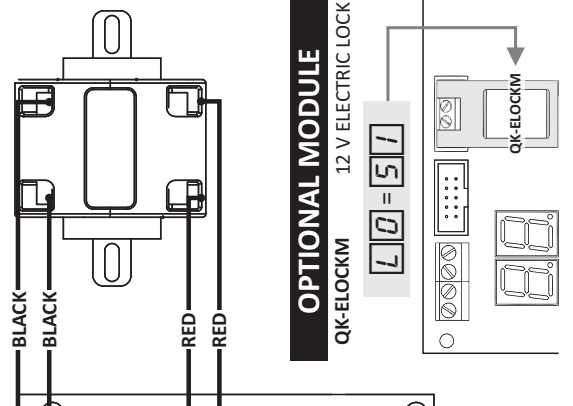
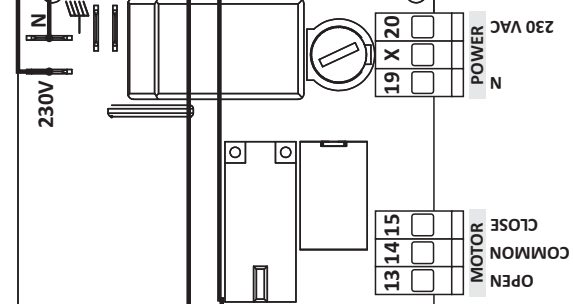
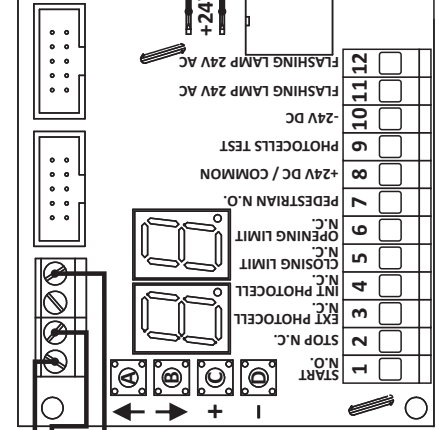
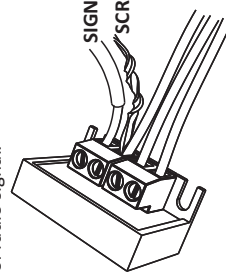

PHOTOCELLS CONNECTION
INTERNAL / OPENING PHOTOCELLS
EXTERNAL / CLOSING PHOTOCELLS

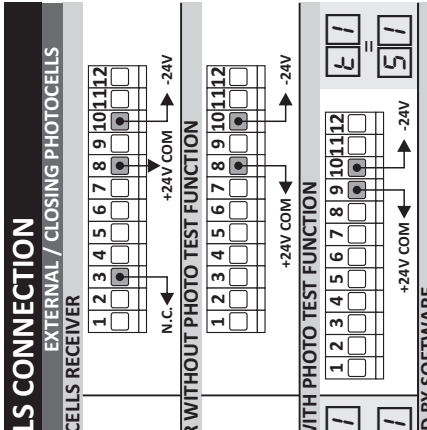
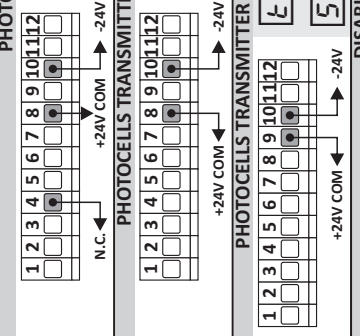

DISABLED BY SOFTWARE
Make sure that the contact is not bridged.



INPUTS / OUTPUTS CONNECTION

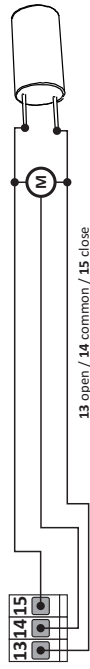
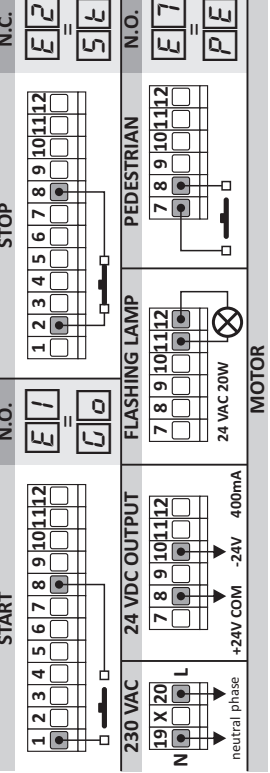

FUNCTION SUMMARY

IMPORTANT NOTICE:

when you see this symbol please refer to the complete user manual for more details. The complete user manual is available for download in the reserved area of our website. quikoitaly.com

MOTOR SETTING

DISPLAY	DEFAULT	<input type="checkbox"/> C MAX	<input type="checkbox"/> D MIN	DESCRIPTION
A1	30 sec	99 sec	00 sec	Standard working time
A2	10 sec	99 sec	00 sec	Slowdown working time
A3	0.1 sec	1.5 sec	0.1 sec	Start up time
A5	7	10	1	Standard force
A6	8	10	1	Slowdown force
A7	NO (DISABLED)	99 - NO	0	Standard obstacle detetion threshold. During opening and closing, for the standard working time, the display shows the motor stress.
A8	NO (DISABLED)	99 - NO	0	Slowdown obstacle detection threshold. During opening and closing, for the slowdown working time, the display shows the motor stress.
A9	12	99	NO	Motor brake duration in centiseconds. Useful to avoid gate getting stuck due to inertia. Set to A9 to disable.
Ab	03	10	01	Motor Brake Power. It stops the gate more suddenly when reaching limit switches.

COURTESY FUNCTIONS

DISPLAY	DISPLAY	<input type="checkbox"/> C	DESCRIPTION
d0	n0	Set Up	To restore default setting hold down <input type="checkbox"/> c button until display shows - -
P1	- -	X	When a start command is received the control board starts an automatic procedure to acquire the gate working times.

BUTTONS

<input type="checkbox"/> A	Scrolls menu from A1 to P2
<input type="checkbox"/> B	Scrolls menu from P2 to A1
<input type="checkbox"/> C	Increases value or set 57 (means: ON or ENABLED).
<input type="checkbox"/> D	Decreases value or set n0 (means: OFF or DISABLED).

GENERAL FUNCTIONS

DISPLAY	DEFAULT	<input type="checkbox"/> C MAX	<input type="checkbox"/> D MIN	DESCRIPTION
F0	10 sec	99 sec	00 sec	Automatic Closure Time. To disable hold down <input type="checkbox"/> c button until display shows 5E
F1	7 sec	A1 sec	0 sec	Pedestrian working time.
F2	0 sec	2.5 sec	0.0 sec	Kick back function during closing.
F3	0.0 sec	5.0 sec	00 sec	Pre-blinking time
F4	NO (OFF)	SI (ON)	NO (OFF)	Kick back function during opening.
F5	NO (OFF)	SI (ON)	NO (OFF)	Step-by-step function
F6	NO (OFF)	SI (ON)	NO (OFF)	Community mode
F7	5.0 sec	5.0 sec	1.5 sec	Fast closure delay
F8	SI	SI	NO	Photocells logic: 57 → Standard logic n0 → Reverse logic
L0	NO (OFF)	SI (ON)	NO (OFF)	Electric-lock
L1	00 min	10 min	00 min	Cold winter function. This function is useful in countries where the winter is extremely cold.
L5	no	E.9	A.1	Assistance request from cycle counter.
L6	X	G.9	A.0	Total working cycles counter
L7	0	1	0	0 = flashing lamp 1 = fixed lamp
E1	NO (OFF)	SI (ON)	NO (OFF)	Photocells test
E2	SI (ON)	SI (ON)	NO (OFF)	Motor thermal protection test

TERMINAL BLOCK SETTING

DISPLAY	<input type="checkbox"/> C	<input type="checkbox"/> D	DESCRIPTION
E1	↓	↑	00 = Start N.O. 0P = Open only N.O. 0L = Close only N.O. P0 = Dead man Open N.O. P1 = Dead man Close N.O. E0 = QK-SMARTM command N.O. EL = Electric-lock command N.O.
E2	↓	↑	n0 = Disabled. 5E = Stop N.C.
E3	↓	↑	n0 = Disabled. E1C = External (closing) photocell N.C. E1D = same like E1C but with possibility to start the opening even If external photocell is detecting an obstacle.
E4	↓	↑	n0 = Disabled. E1A = Internal(opening) photocell N.C.
E5	↓	↑	n0 = Disabled. F1C = Closing limit switch N.C. L1C = Closing limit switch N.O.
E6	↓	↑	n0 = Disabled. F1A = Opening limit switch N.C. L1A = Opening limit switch N.O.
E7	↓	↑	P1E = Pedestrian N.O. 0P = Open only N.O. 0L = Close only N.O. P0 = Dead man Open N.O. P1C = Dead man Close N.O. E0 = QK-SMARTM command N.O. EL = Electric-lock command N.O.

RADIO FUNCTIONS

DISPLAY	<input type="checkbox"/> C	DESCRIPTION
r0	Delete	To erase a remote control: Hold down <input type="checkbox"/> C button on the selected code until the display turns off - -
r1 to r4	Save	To save a remote control key: Hold down a remote key. When the display shows - - , push down <input type="checkbox"/> C button on the control board. r1 → Start r2 → Stop r3 → Pedestrian start r4 → Fast closure start
r5	Delete	To erase all codes: Hold down <input type="checkbox"/> C button until display stops flashing 57
r6 to r8	Save	Programmable radio functions. Save a remote as one of following functions: Only Open 0P , Only Close 0L , open Dead Man P0 , close Dead Man P1C , electric lock EL .

DISPLAY REPORTS

5E	Stop.
FH	External (closing) + Internal (opening) photocells.
E1C	External (closing) photocell mode 1
E1D	External(closing) photocell mode 2
E1A	Internal(opening) photocell.
00	Start
F0	Fast Closure Start
P1E	Pedestrian opening
0P	Open Only.
0L	Close Only.
P0	Dead man Open
P1C	Dead man Close
EL	Electric-lock
E0	QK-SMARTM command N.O.
1H	Opening limit switch + Closing limit switch.
F1A	Opening limit switch. Normally Closed.
F1C	Closing limit switch. Normally Closed.
L1A	Opening limit switch. Normally Open.
L1C	Closing limit switch. Normally Open.
5L	Assistance request from cycle counter.
- -	Remote key is pressed.
0E	Board damaged by over-voltage.
1E	Photocells test error.
7A	Motor has detected an obstacle during the standard working time.
8A	Motor has detected an obstacle during the slowdown working time.
9A	Motor is in thermal protection state.
FE	The radio memory is full.

S'ASSURER QUE LE MOTEUR TOURNE DANS LE BON SENS

Une fois que toutes les connexions sont faites et que le système est prêt à fonctionner, avant de configurer ce dernier il est important de vérifier que le moteur tourne dans le bon sens, pour ce faire :

1. Couper le courant.
2. débloquer le moteur et porter le vantail manuellement à une position au milieu.
3. Remettre le courant.
4. Donner une première commande start à l'aide d'un transmetteur ou d'un bouton poussoir.
5. S'assurer que le moteur ouvre.
6. Si le moteur ferme, inverser les phases du moteur (13 - 15) et les câbles de fins de course (5 - 6).

MOTEUR

FIN DE COURSE

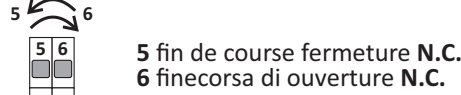
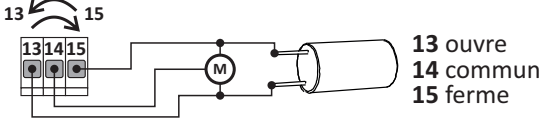

7. Une fois les câbles de phases inversés, après avoir remis le courant répéter la procédure et s'assurer qu'à la première commande start, le moteur ouvre.
8. Le système est maintenant prêt pour la configuration.

INSTALLATION DU MODULE RADIO

Le module radio est installé par l'usine à l'intérieur de la boîte en plastique de la centrale de commande. Le signal radio est assez bon dans la plus part des cas. Si l'on souhaite augmenter la portée du signal encore plus, installer le module radio comme l'un des exemples suivants:

À L'INTÉRIEUR DU BOÎTIER DE L'ANTENNE

BOÎTIER DE L'ANTENNE AVEC LAMPE CLIGNOTANTE

À L'INTÉRIEUR DE LA LAMPE CLIGNOTANTE

optionnel
QK-AN433_V4

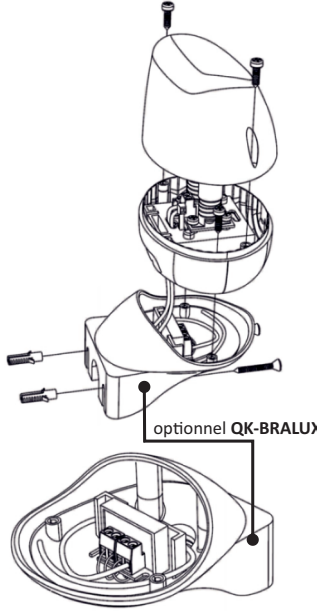
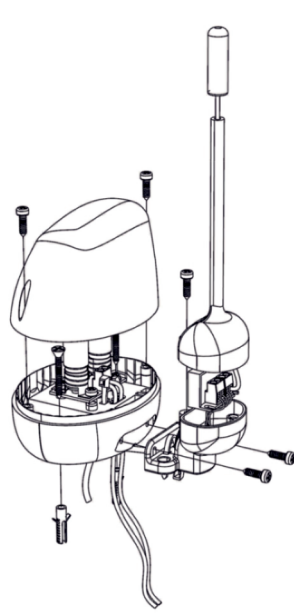
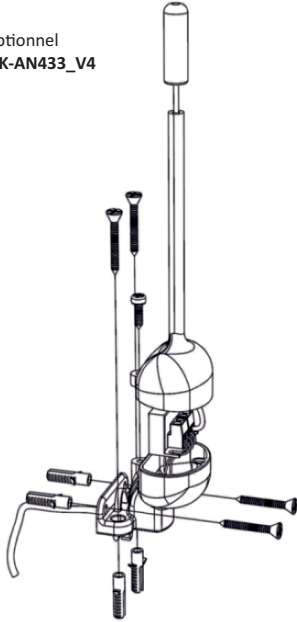

QuiKo déclare sous sa propre responsabilité que le produit est conforme aux principales exigences de sécurité délivrées par les directives suivantes : 1) Équipement radio 1999/05/CE – 2) Basse tension 2006/95/CE – 3) Compatibilité électromagnétique 2004/108/CE et les révisions y afférentes ainsi qu'aux dispositions qui appliquent les dites directives dans la législation nationale du pays où les produits seront utilisés.



GUIDE RAPIDE

QK-CE220RL4

CENTRALE DE COMMANDE POUR PORTAILS COULISSANTS 230V

V24 HS2124

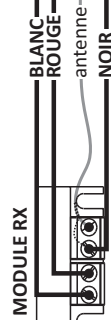

MODULE RX: Placer à l'intérieur du clignotant ou dans le boîtier de l'antenne pour augmenter la portée du signal.

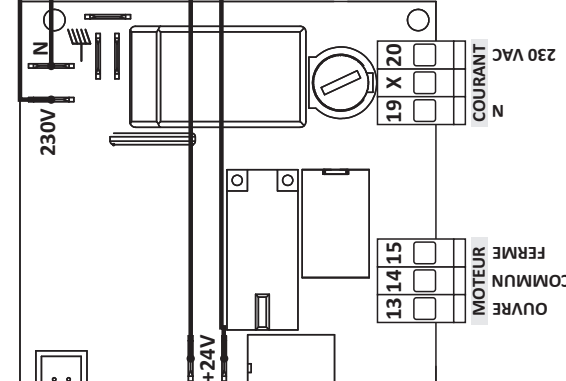
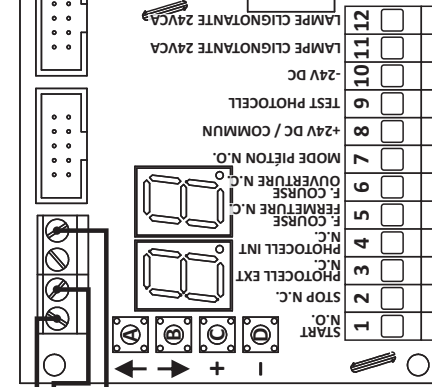
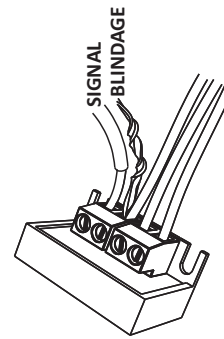

MODULE OPTIONNEL

QK-ELOCKM ÉLECTRO-SERRURE 12V

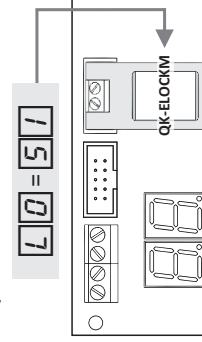

BRANCHEMENTS DES PHOTOCELLULES

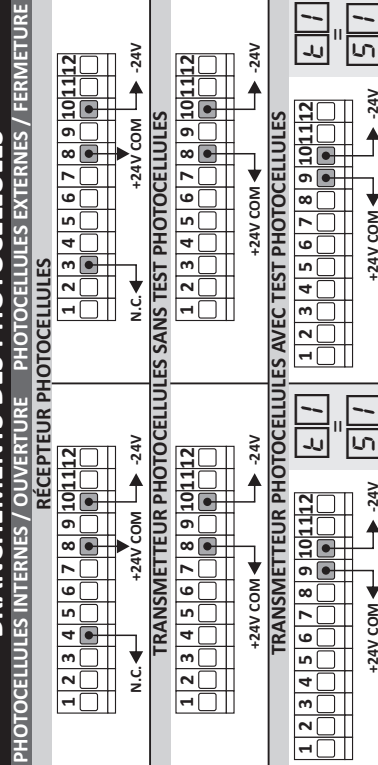

Si l'on veut connecter une antenne câblée RG59 externe connecter le câble et le blindage comme dans l'image ci-dessus.

ENTRÉES PHOTOCELLULES DÉSACTIVÉ PAR SOFTWARE

Vérifier que le contact ne soit pas relié.

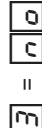
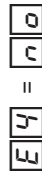

BRANCHEMENT DES ENTRÉES / SORTIES

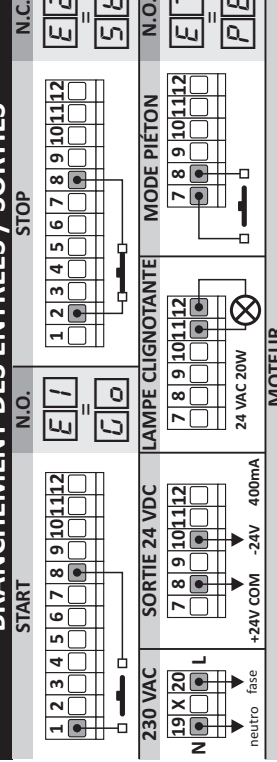

MOTEUR



SOMMAIRE DES FONCTIONS

AVIS IMPORTANT: le symbole ci-contre invite à consulter le manuel d'utilisation complet pour plus de détails. Ce manuel est disponible en téléchargement dans l'espace réservé de notre site.

Quikoitaly.com

MOTEUR

AFFICHAGE	DÉFAUT	<input type="checkbox"/> C MAX	<input type="checkbox"/> D MIN	DÉSCRIPTION
R1	30 sec	99 sec	00 sec	Temps de travail standard
R2	10 sec	99 sec	00 sec	Temps de travail au ralenti
R3	0.1 sec	1.5 sec	0.1 sec	Temps de démarrage
R5	7	10	1	Force standard
R6	8	10	1	Force au ralenti
R7	NO (DÉSACTIVÉ)	99 - NO	0	Seuil detection obstacles en mode standard. Durant l'ouverture, pour un temps de travail standard, l'afficheur indique l'effort du moteur.
R8	NO (DÉSACTIVÉ)	99 - NO	0	Seuil detection obstacles en mode ralenti. Durant l'ouverture, pour un temps de travail ralenti, l'afficheur indique l'effort du moteur.
R9	12	99	NO	Frein moteur en centiemes de seconde apres l'activation de la fin de course. Utile pour eviter que le portail ne se coince a cause de l'inertie. Regler sur <input type="checkbox"/> pour desactiver.
Rb	03	10	01	Puissance de frein moteur. Il arrête le portail plus rapidement lorsqu'il touche les fins de course.

FONCTIONS DE COURTOISIE

AFFICHAGE	<input type="checkbox"/> C	DÉSCRIPTION
d0	<input type="checkbox"/> <input type="checkbox"/>	Pour retablir la configuration par défaut appuyer sur le bouton <input type="checkbox"/> C jusqu'a ce que l'afficheur indique <input type="checkbox"/> <input type="checkbox"/>
P1	<input type="checkbox"/> <input type="checkbox"/>	Quand une commande start est recue la centrale entame une procedure automatique pour connaitre le temps detravail du portail.

BOUTONS

<input type="checkbox"/> A	défile le menu de R1 à P2
<input type="checkbox"/> B	défile le menu de P2 à R1
<input type="checkbox"/> C	Augmente la valeur ou définit S1 ON ou ACTIVÉ
<input type="checkbox"/> D	Diminue la valeur ou définit n0 OFF ou DÉSACTIVÉ

FONCTIONS GENERALES

AFFICHAGE	DÉFAUT	<input type="checkbox"/> C MAX	<input type="checkbox"/> D MIN	DÉSCRIPTION
F0	10 sec	99 sec	00 sec	Temps de fermeture automatique. Pour desactiver appuyer sur le bouton <input type="checkbox"/> C jusqu'a ce que l'afficheur montre S1
F1	7 sec	R1 sec	0 sec	Temps mode pieton
F2	0 sec	2.5 sec	0.0 sec	Coup de fermeture. Elle est utile en presence d'une electroserrure.
F3	0.0 sec	5.0 sec	00 sec	Temps de pre-clignotement
F4	NO (OFF)	SI (ON)	NO (OFF)	Coup d'ouverture. Elle est utile en presence d'une electroserrure
F5	NO (OFF)	SI (ON)	NO (OFF)	Pas à pas
F6	NO (OFF)	SI (ON)	NO (OFF)	Mode copropriete
F7	5.0 sec	5.0 sec	1.5 sec	Temps de fermeture rapide
F8	SI	SI	NO	Logique de photocellule: S1 → Logique standard n0 → Logique inverse
L0	NO (OFF)	SI (ON)	NO (OFF)	Électro-serrure
L1	00 min	10 min	00 min	Fonction hiver froid. Cette fonction est utile dans les pays ou l'hiver est particulierementfroid.
L5	no	E.9	A.1	Demande d'assistance du compteur de cycles.
L6	x	G.9	A.0	Compteur du total des cycles de travail.
L7	0	1	0	0 = lampe clignotante 1 = lampe fixe
t1	NO (OFF)	SI (ON)	NO (OFF)	Test photocellules
t2	SI (ON)	SI (ON)	NO (OFF)	Test moteurs en surchauffe

FONCTIONS RADIO

AFFICHAGE	<input type="checkbox"/> C	DÉSCRIPTION
r0 1...2...	<input type="checkbox"/>	Effacer
r1 r2 r3 r4	<input type="checkbox"/>	Sauver r1 → Start r2 → Stop r3 → Start mode pieton r4 → Start fermeture rapide
r5 n0	<input type="checkbox"/>	Effacer r5 → Effacer tous les codes: maintenir appuye le bouton <input type="checkbox"/> C jusqu'a ce que l'afficheur arrete de clignoter S1
r6 r7 r8	<input type="checkbox"/>	Sauver r6 → Ouvre seulement r7 → Ferme seulement r8 → Ouverture homme mort r9 → Fermeture homme mort rE → Electro serrure

REGLAGE DU BORNIER

AFFICHAGE	<input type="checkbox"/> C	<input type="checkbox"/> D	DÉSCRIPTION
E1	↓	↑	E1 = Start N.O. oP = Ouvre seulement N.O. CL = Ferme seulement N.O. po = Ouverture homme mort N.O. PC = Fermeture homme mort N.O. Eo = Commande QK-SMARTM N.O. EL = Commande electro serrure N.O.
E2	↓	↑	n0 = Desactive S1 = Stop N.C.
E3	↓	↑	n0 = Desactive EC = Photocellule externe (de fermeture) N.F. ED = pareil que EC avec la possibilite d'ouverture meme si la photocellule externe detecte un obstacle.
E4	↓	↑	n0 = Desactive ER = Photocellule interne (d'ouverture) N.C.
E5	↓	↑	n0 = Desactive FC = Fin de course de fermeture N.C. LC = Fin de course de fermeture N.O.
E6	↓	↑	n0 = Desactive FR = Fin de course d'ouverture N.C. LR = Fin de course d'ouverture N.O.
E7	↓	↑	PE = Mode pieton N.O. oP = Ouvre seulement N.O. CL = Ferme seulement N.O. po = Ouverture homme mort N.O. PC = Fermeture homme mort N.O. Eo = Commande QK-SMARTM N.O. EL = Commande electro serrure N.O.

SIGNALISATIONS

S1	Stop
FH	Photocellule externe (fermeture) + Photocellule interne (ouverture)
EC	Photocellule externe (fermeture) modalité 1
ED	Photocellule externe (fermeture) modalité 2
ER	Photocellule interne (ouverture)
Go	Start
F0	Start fermeture rapide
PE	Start mode pieton
oP	Ouvre seulement
CL	Ferme seulement
po	Ouverture homme mort
PC	Fermeture homme mort
EL	Commande electroserrure
Eo	QK-SMARTM commande N.O.
IH	Fin de course ouverture + Fin de course fermeture
FR	Fin de course ouverture N.C.
FC	Fin de course fermeture N.C.
LR	Fin de course ouverture N.O.
LC	Fin de course fermeture N.O.
SL	Demande d'assistance du compteur de cycles
- -	Emetteur appuye
0E	Centrale endomagee pour cause de surtension
1E	Erreur test photocellule
7A	Le moteur a detecte un obstacle
8A	Le moteur a detecte un obstacle pendant le cycle de travail au ralenti
9A	Le moteur est en protection thermique
FF	Memoire radio pleine